

SOLAR EXPERTS IN CENTRAL INDIA

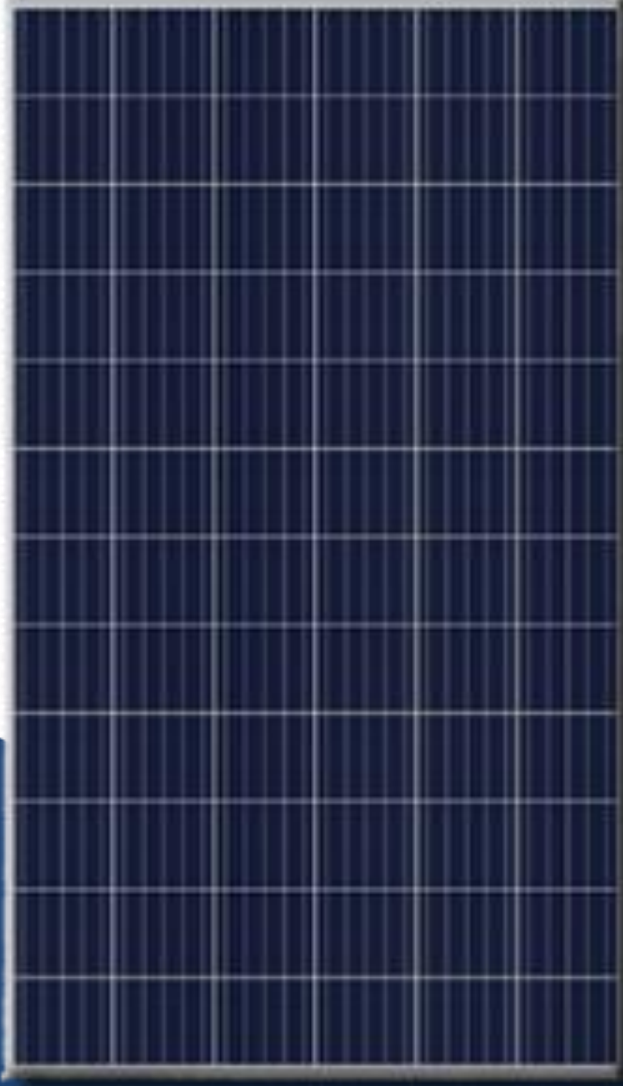

SOLAR POLYCRYSTALLINE MODULE

MODEL NO. : AE72FP340WP



KEY FEATURES

- ✓ Excellent Power Output with **+ve** Tolerance (**up to 2%**)
- ✓ Generate Power even at Low Light
- ✓ High Performance Modules with high efficiency
- ✓ PID Resistance
- ✓ Safety class II
- ✓ ARC, Ultra-clear toughened and textured glass
- ✓ Pre-drilled frame for easy mounting
- ✓ IP-68 rated Junction Box
- ✓ Solar MC4 compatible connector
- ✓ Fire safety class **C**

 Highly Efficient

 PID free modules

 Outstanding Power performance



AVERT ENERGY INDIA PVT.LTD.

TUTA, ATAL NAGAR - NYAYA RAIPUR (C.G.) - 492015

EMAIL : avertenergyindia@gmail.com | ph: 8962828882, 9425202583



IS 14286:2010/IEC61215:2005,
IS/IEC 61730(PART 1):2004
IS/IEC61730 (PART 2):2004



COMPOSITION LAYERS OF POLYCRYSTALLINE MODULE

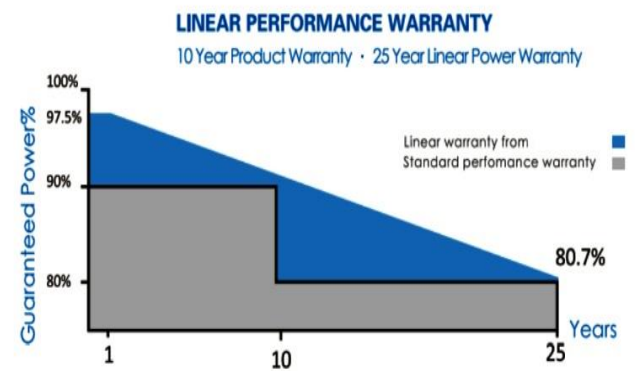

Linear Power Guarantee on Avert Energy modules 97% upto 1 year then @ 0.63% / year

BACK VIEW

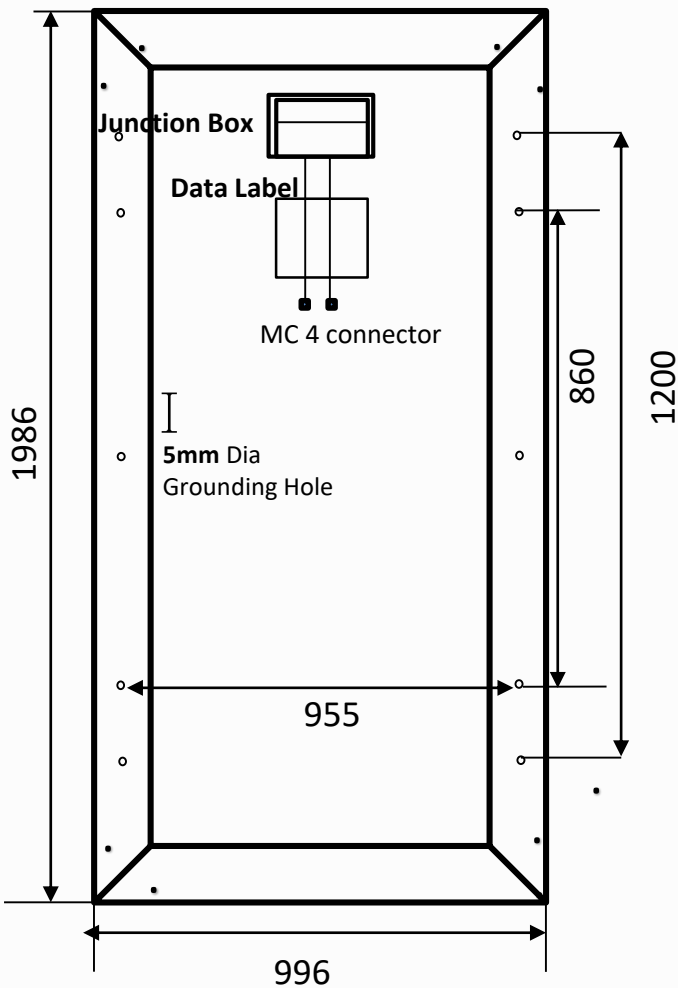

NOTE: All DIMENSIONS ARE IN MM (± 1 mm)

AI SECTION

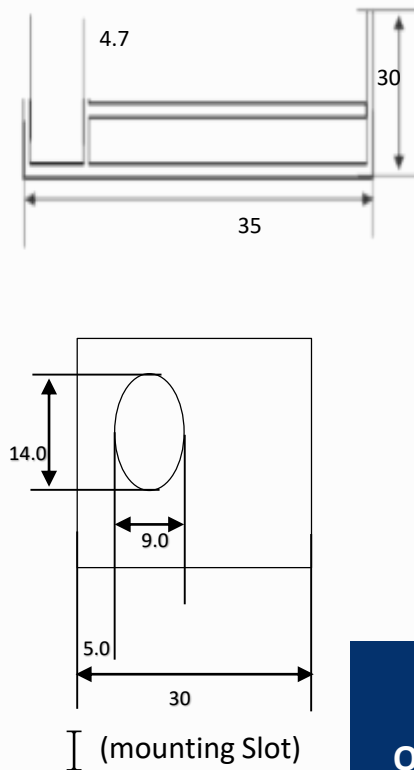

I-V CURVE

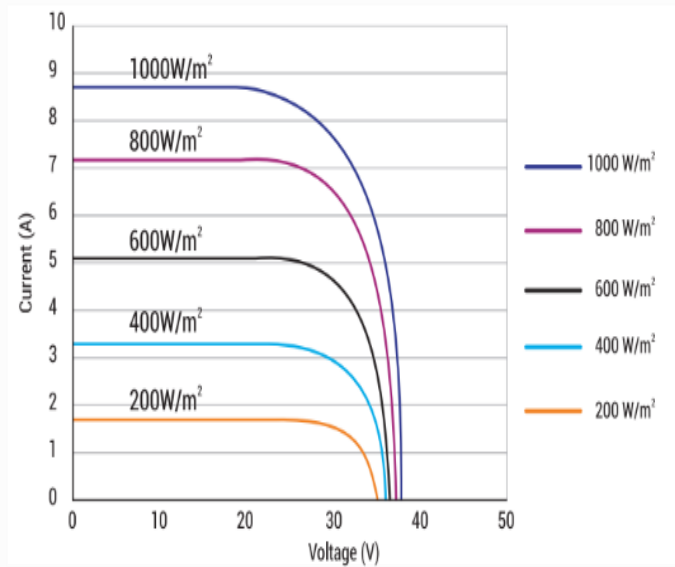

Thermal Specifications

Operating Conditions - (- 40 °C to + 85° C at 85% RH)
Temperature Co-efficient for Voc/ °C - (β) -0.30%
Temperature Co-efficient for Isc/ °C - (α) 0.03%
Temperature Co-efficient for power/ °C - (γ) -0.39%

Electrical Specifications

STC Condition	1.5 AM/1000W/m ² 25 °C
Module WP	340 WP
No of Cell in Series	72 Cell
Short Circuit current (Isc)	9.45 A
Open Circuit Voltage(Voc)	46.00 V
Maximum Voltage (Vmp)	37.70 V
Maximum Current (Imp)	9.02 A
Fill Factor	82.01 %
Module Efficiency	17.19 %
System Voltage	1500 VDC
Cell Size in mm	158.75 X 158.75

Mechanical Specifications

Module Weight	21 kg
Module Dimension (A)*(B)*(C)	1986 x 996 x 35 mm
Mounting Hole(Oblong Size)	9 x 14 mm
Mounting Hole CTC distance – vertical (H)	860 mm
Mounting Hole distance from corner (E)	563 mm
Mounting Hole CTC distance – horizontal(F)	955 mm
Junction Box	Dash 1 Meter
Connector	MC4 Connector
Glass	2.8 mm



Headquarter - Lalganga Business Park, 5th Floor 517, Pachpedi Naka, Raipur (C.G.) 492001 India

